

FUSIBLE LINK ②

ENGINE-ECU (D-245) \*1  
ENGINE-A/T-ECU (D-216) \*2

ASTC-ECU (D-223)

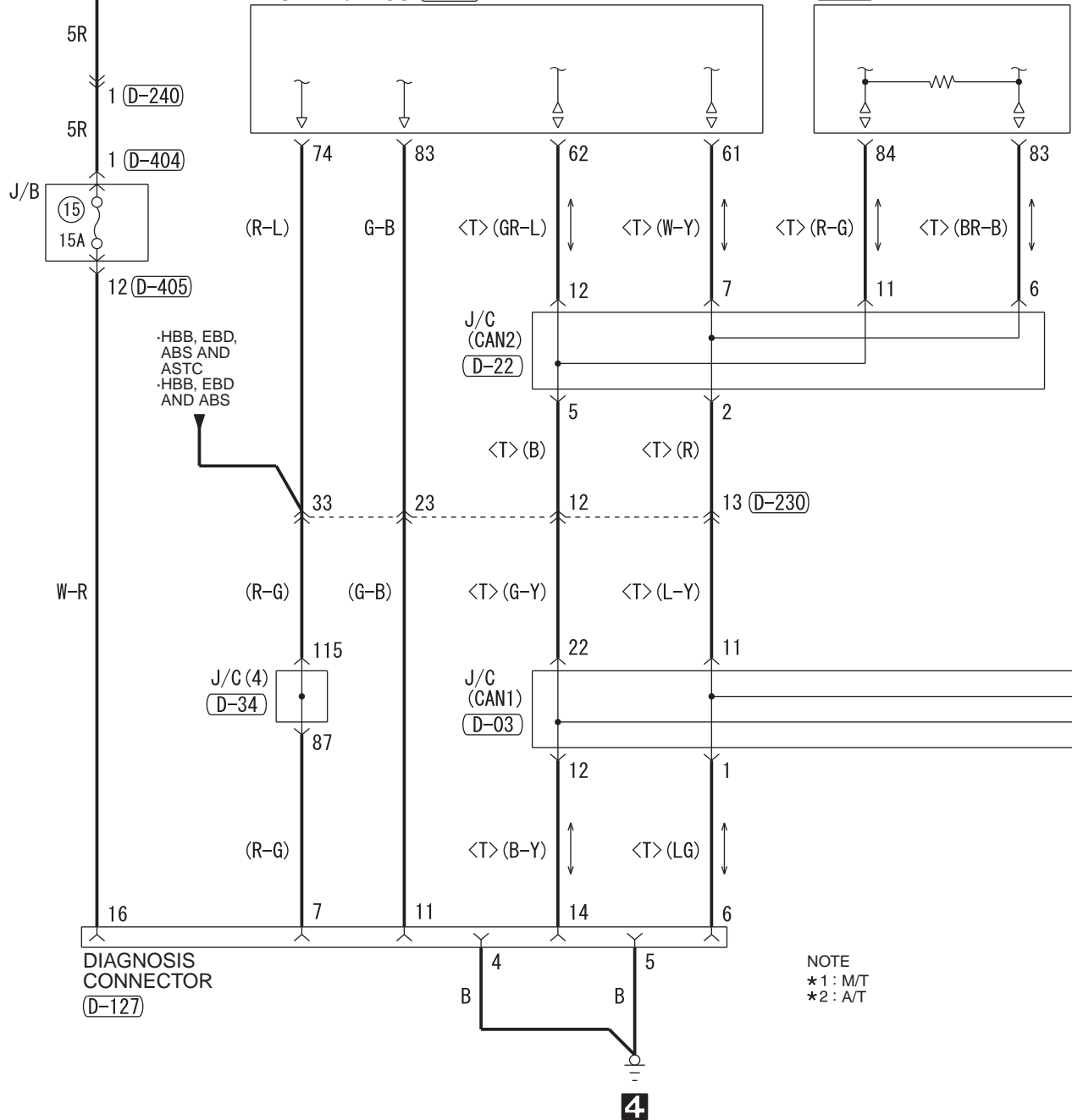

NOTE  
\*1 : M/T  
\*2 : A/T

FUSIBLE LINK ①

J/B (FUSE ②)

- APPROACH LAMP
- AUDIO SYSTEM
- AUTOMATIC AIR CONDITIONER
- CENTRAL DOOR LOCKING SYSTEM
- CENTRE DISPLAY
- CLOCK
- DOOR AJAR WARNING BUZZER
- DOOR LAMP
- ELECTRIC RETRACTABLE REMOTE CONTROLLED MIRROR
- FOOT LAMP AND CEILING LAMP
- FORGOTTEN KEY PREVENTION FUNCTION
- FRONT FOG LAMP
- HANDS-FREE CELLULAR PHONE SYSTEM
- HBB, EBD, ABS AND ASTC
- HEADLAMP
- HEADLAMP WASHER
- POWER WINDOWS
- REAR FOG LAMP
- REAR SEAT ENTERTAINMENT SYSTEM
- REAR WIPER AND WASHER
- ROOM LAMP, PERSONAL LAMP, LUGGAGE COMPARTMENT LAMP AND IGNITION KEY CYLINDER ILLUMINATION LAMP
- SEAT BELT WARNING BUZZER
- SECURITY ALARM
- SPARE CONNECTOR (FOR ACCESSORY)
- SPARE CONNECTOR (FOR AUDIO)
- SUNROOF
- TAIL LAMP, POSITION LAMP, LICENCE PLATE LAMP AND LIGHTING MONITOR BUZZER
- TURN-SIGNAL LAMP AND HAZARD WARNING LAMP
- USB BOX
- VANITY MIRROR LAMP
- WINDSHIELD WIPER AND WASHER

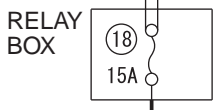

0.85R-B  
15 (D-241)

0.85R-B

R-B

(D-02) 31

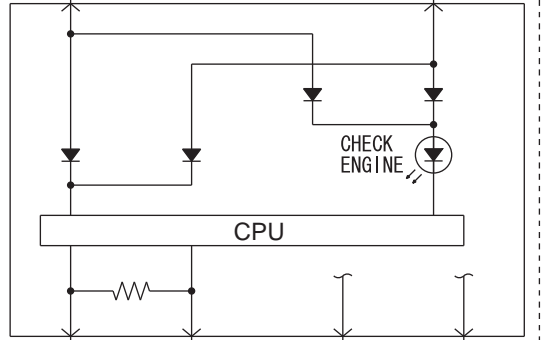

23

24 (D-04)

41

52

B

B

23

24 (D-04)

41

52

B

B

23

24 (D-04)

41

52

B

B

23

24 (D-04)

41

52

B

B

23

24 (D-04)

41

52

B

B

23

24 (D-04)

41

52

B

B

23

24 (D-04)

41

52

B

B

23

24 (D-04)

41

52

B

B

23

24 (D-04)

41

52

B

B

(D-216) (MU803804)

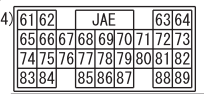

(D-223)

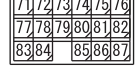

(D-230)

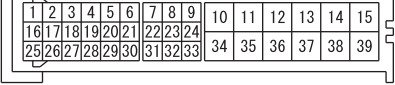

(D-240) MU801405



(D-02) MU801515

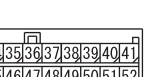

(D-03) MU801516

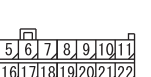

(D-04)

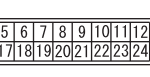

(D-22) MU801516

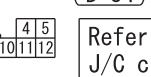

(D-34) Refer to J/C circuit

(D-127) FRONT SIDE MU803797

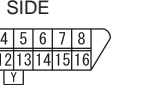

(D-241)

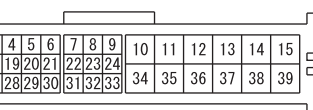

(D-245) (MU803804)

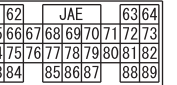

(D-404) MU801403



Wire colour code  
 B : Black LG : Light green G : Green L : Blue W : White  
 Y : Yellow SB : Sky blue BR : Brown O : Orange GR : Grey  
 R : Red P : Pink V : Violet PU : Purple SI : Silver