

<VEHICLES WITH SIDE-AIRBAG AND CURTAIN AIR BAG>

<LONG WHEELBASE WITH SIDE-AIRBAG AND CURTAIN AIR BAG>

SEAT BELT PRE-TENSIONER (RH) (E-30)

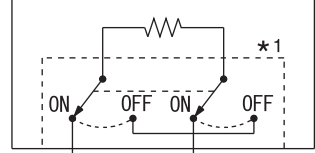

SIDE-AIRBAG MODULE (SQUIB) (RH) (E-127)

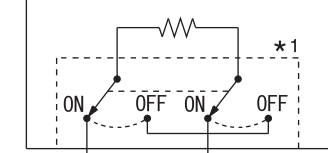

CURTAIN AIR BAG MODULE (SQUIB) (RH) (E-04)

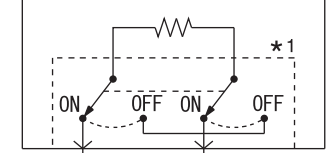

SIDE IMPACT SENSOR (FRONT: RH) (E-28)

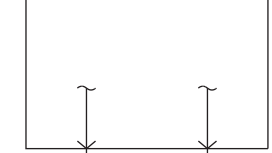

SIDE IMPACT SENSOR (REAR: RH) (E-33)

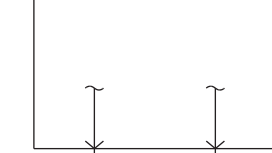

SRS-ECU

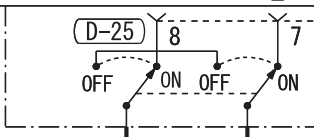
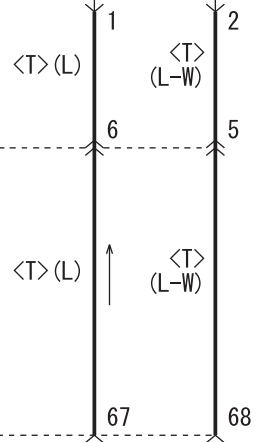
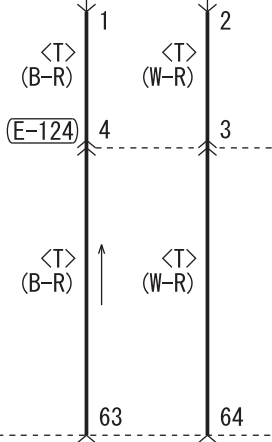
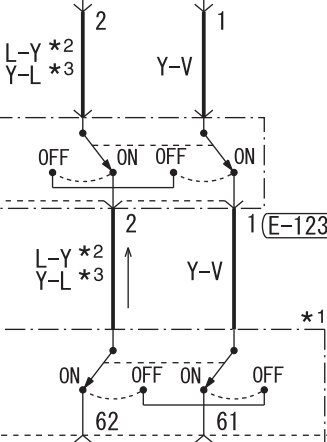
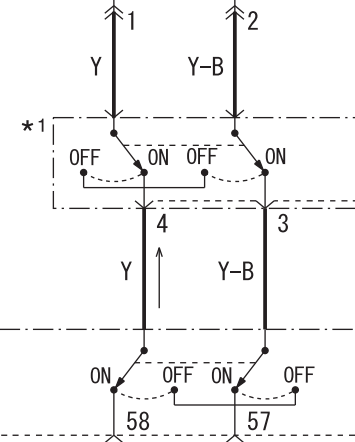
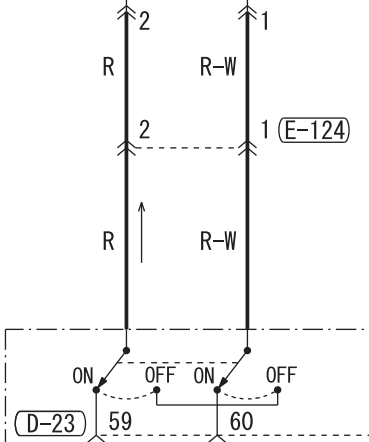

SEAT BELT PRE-TENSIONER (LH) (E-16)

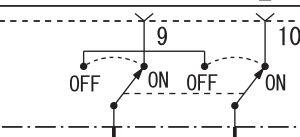

SIDE-AIRBAG MODULE (SQUIB) (LH) (E-121)

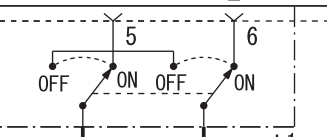

CURTAIN AIR BAG MODULE (SQUIB) (LH) (E-08)

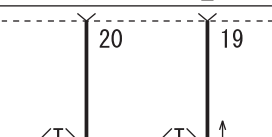

SIDE IMPACT SENSOR (FRONT: LH) (E-18)

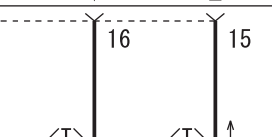

SIDE IMPACT SENSOR (REAR: LH) (E-40)

NOTE
*1: CONNECTOR LOCK SWITCH (CONNECTOR COUPLED: ON, CONNECTOR UNCOUPLED: OFF)
*2: LHD
*3: RHD

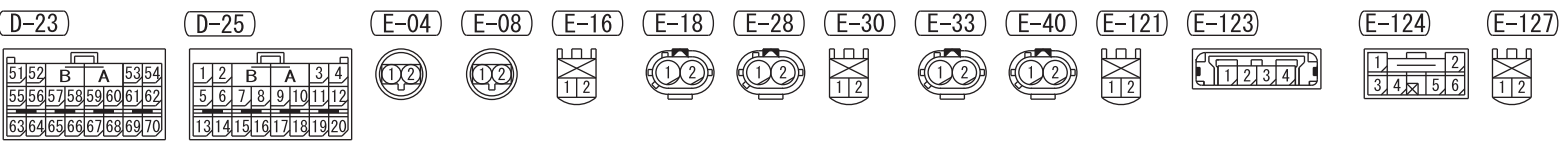

Wire colour code
B: Black LG: Light green G: Green L: Blue W: White Y: Yellow SB: Sky blue
BR: Brown O: Orange GR: Grey R: Red P: Pink V: Violet PU: Purple SI: Silver